

Vaginal Specula Scheidenspekula

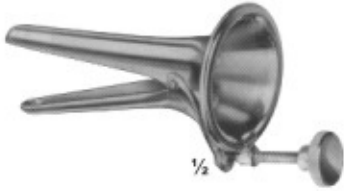

10-101
COLLIN
for children
53 x 10 mm

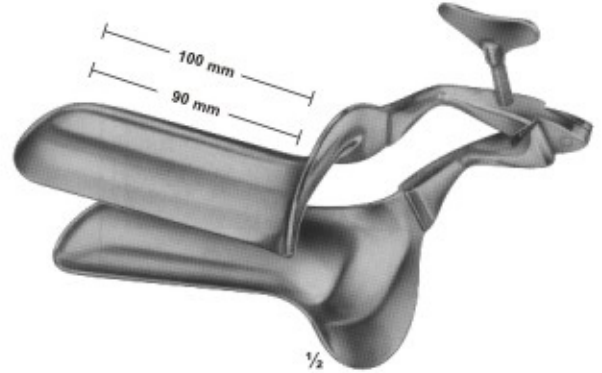

10-102 - 105
COLLIN

10-102	100/90mm	28 mm
10-103	100/90mm	32 mm
10-104	105/95mm	35 mm
10-105	115/105mm	40 mm
Total length/working length		width



10-106
COLLIN
for virgins
95/85 x 18 mm



10-107
CUSCO
for virgins
75 x 17 mm



10-108
CUSCO
for virgins
75 x 17 mm

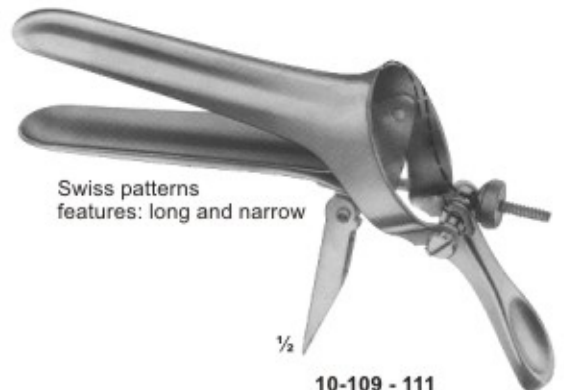

Swiss patterns
features: long and narrow

10-109 - 111
CUSCO

10-109	92X23-25 mm
10-110	100x25-27 mm
10-111	110x27-30 mm

Vaginal Specula- Sets, upper and lower blades Scheidenspekula-Satze, obere und untere Blätter



10-112 - 114
GRAVE
10-112 75X20 mm
10-113 95X30 mm
10-114 105X33 mm

½



10-115 - 116
PEDERSON
10-115 100X22 mm
10-116 120X25 mm

½

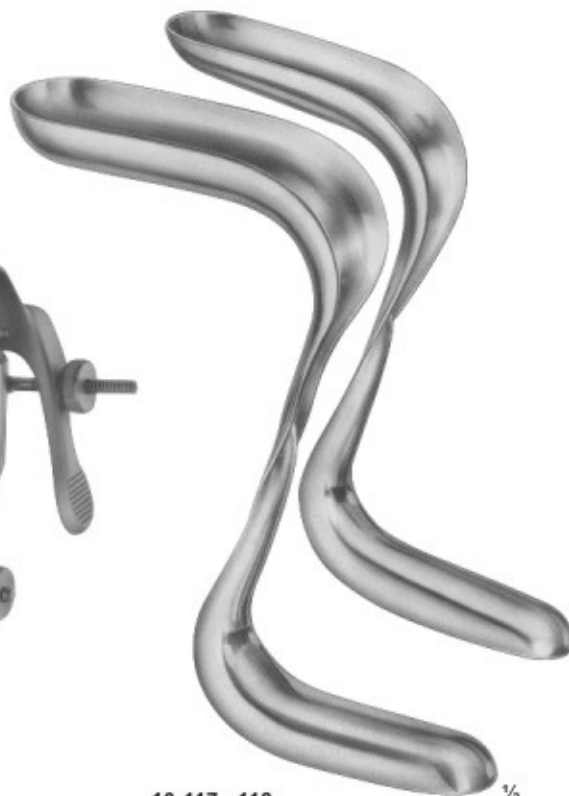

10-117 - 118
BRIESKY
10-117 72X25 mm / 77X30 mm 140 mm
10-118 75X30 mm / 92X38 mm 170 mm

½



10-119 - 120
SIMS
70 X 26 mm / 75 X 30 mm
75 X 30 mm / 80 X 35 mm
80 X 36 mm / 90 X 40 mm
175 mm

½



10-121 - 123
SEIDL
10-121 80X8 mm
10-122 80X10 mm
10-123 90X14 mm
For children and infants
170 mm

½



10-124
KRISTELLER
70X15 mm, (170 mm)
For children

½



10-125 - 127
KRISTELLER
10-125 70X27 mm
10-126 75X30 mm
10-127 90X36 mm
175 mm

½

Vaginal Specula- upper and lower blades

Scheidenspekula-obere und untere Blätter

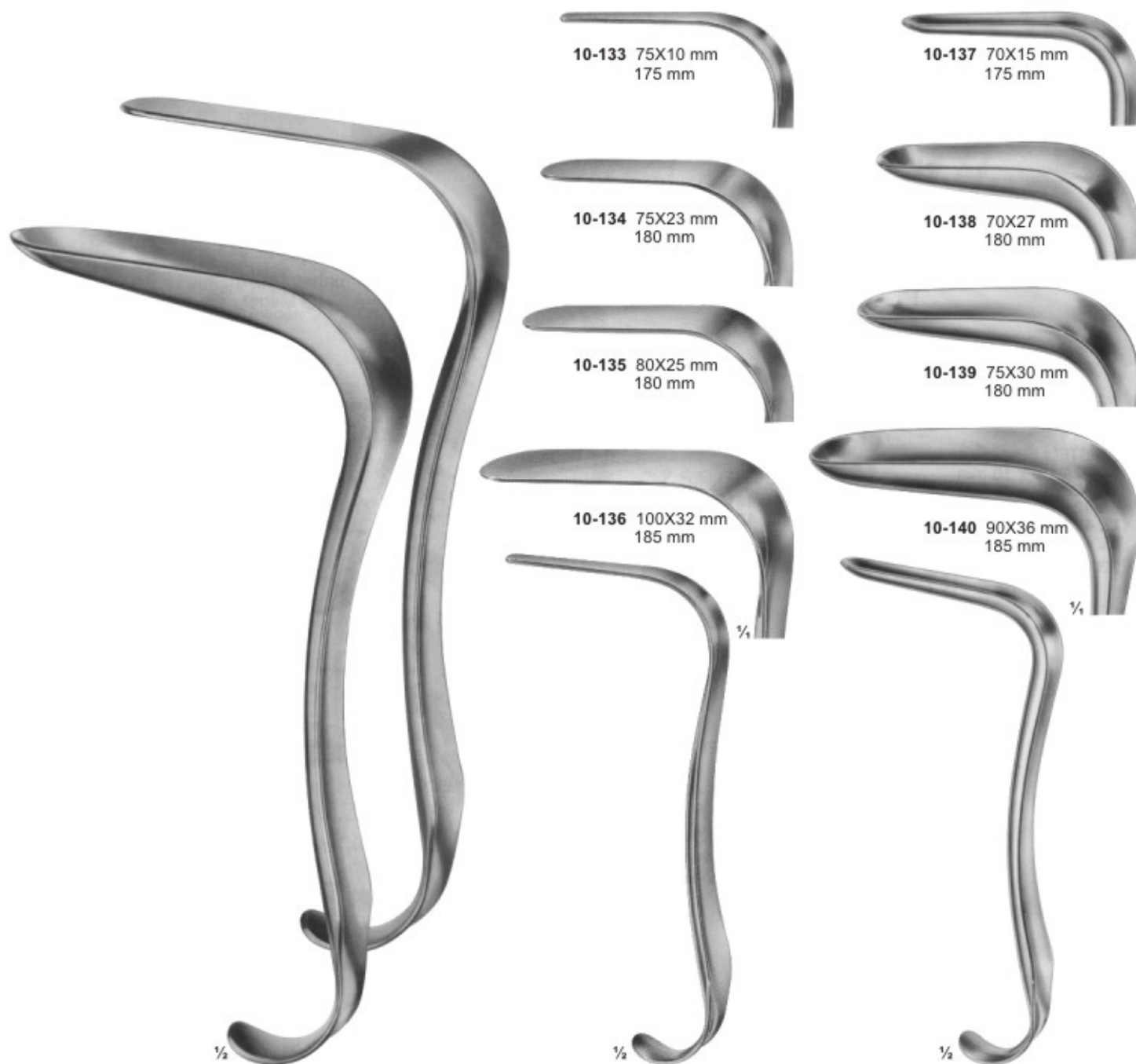

10-128 - 132
KRISTELLER
10-128 110X18 mm
10-129 110X20 mm
10-130 110X27 mm
10-131 110X30 mm
10-132 110X36 mm
220 mm

10-133 - 136
KRISTELLER
Upper blades

10-137 - 140
KRISTELLER
Lower blades

Vaginal Specula Scheidenspekula

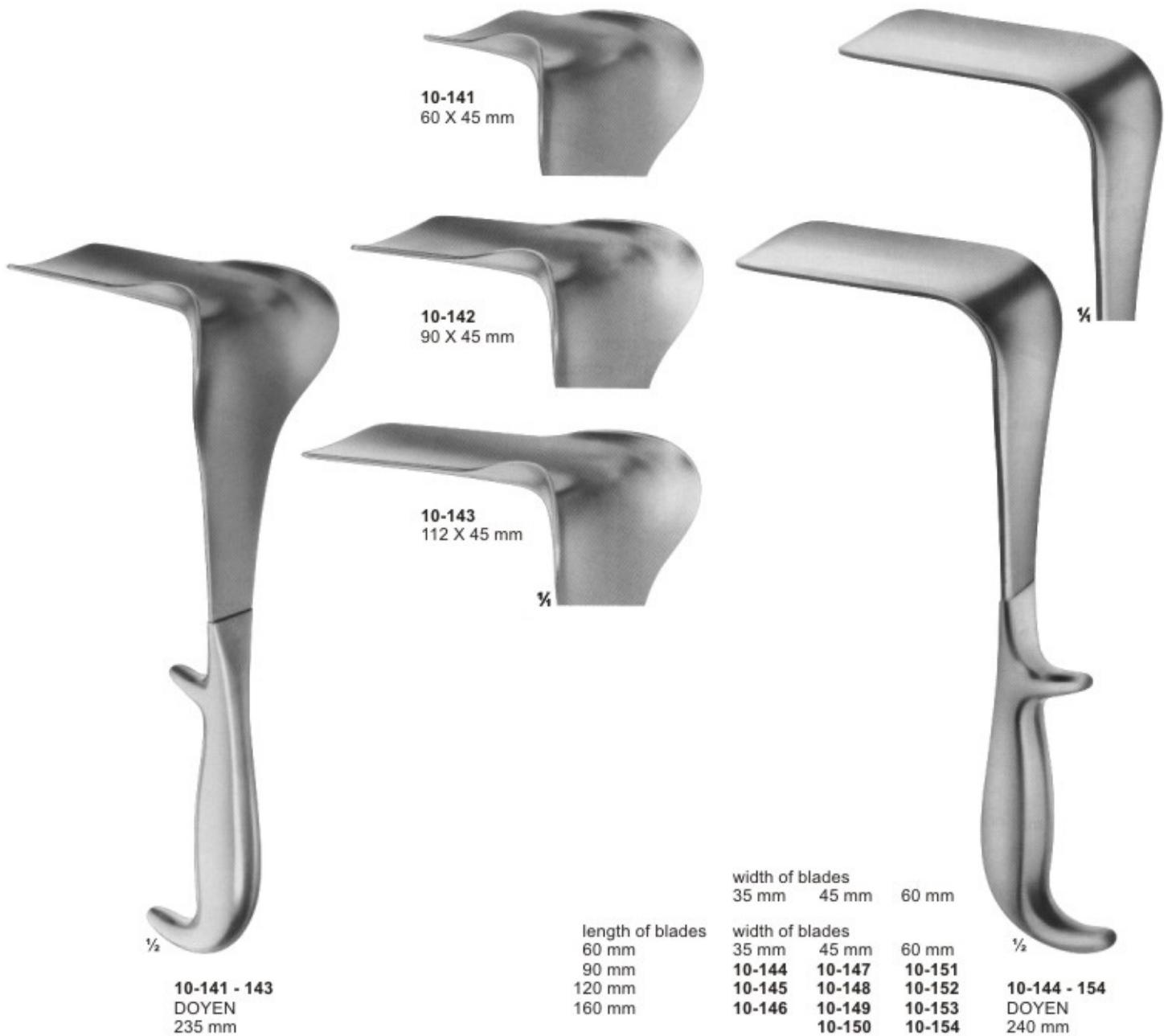

10-141
60 X 45 mm

10-142
90 X 45 mm

10-143
112 X 45 mm

$\frac{1}{2}$
10-141 - 143
DOYEN
235 mm

length of blades
60 mm
90 mm
120 mm
160 mm

width of blades		
35 mm	45 mm	60 mm

width of blades		
35 mm	45 mm	60 mm
10-144	10-147	10-151
10-145	10-148	10-152
10-146	10-149	10-153
	10-150	10-154

$\frac{1}{2}$
10-144 - 154
DOYEN
240 mm

Vaginal Retractors

Vulva-Spreizer



1/2
10-155
JOLL (FRIEDMAN)
155 mm



1/2
10-156
RICHTER
170 mm



1/2
10-157
GELPI
135 mm



1/2
10-158
GELPI
175 mm

Uterine Dilators

Uterus-Dilatatoren



11-101 - 143
HEGAR
with very conical point
185 mm

11-101	1	mm	11-123	23	mm
11-102	2	mm	11-124	24	mm
11-103	3	mm	11-125	25	mm
11-104	4	mm	11-126	26	mm
11-105	5	mm	11-127	1	½mm
11-106	6	mm	11-128	2	½mm
11-107	7	mm	11-129	3	½mm
11-108	8	mm	11-130	4	½mm
11-109	9	mm	11-131	5	½mm
11-110	10	mm	11-132	6	½mm
11-111	11	mm	11-133	7	½mm
11-112	12	mm	11-134	8	½mm
11-113	13	mm	11-135	9	½mm
11-114	14	mm	11-136	10	½mm
11-115	15	mm	11-137	11	½mm
11-116	16	mm	11-138	12	½mm
11-117	17	mm	11-139	13	½mm
11-118	18	mm	11-140	14	½mm
11-119	19	mm	11-141	15	½mm
11-120	20	mm	11-142	16	½mm
11-121	21	mm	11-143	17	½mm
11-122	22	mm			



11-144 - 152
HEGAR
205 mm

11-144	1+2	mm
11-145	3+4	mm
11-146	5+6	mm
11-147	7+8	mm
11-148	9+10	mm
11-149	11+12	mm
11-150	13+14	mm
11-151	15+16	mm
11-152	17+18	mm

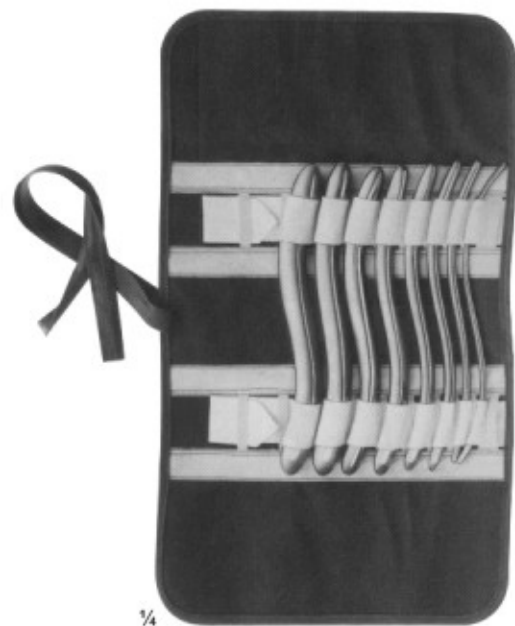

11-153
HEGAR
Uterine dilator set, in canvas
roll with 8 dilators.